

Cable connector, NAMUR V1-W-N-2M-PUR

- Suitable for NAMUR technology
- Degree of protection IP68 / IP69
- Suitable for routing intrinsically safe circuits in accordance with DIN EN 60079-14:2014
- Specific design protects against loosening and inaccurate installation

Female cordset single-ended M12 angled A-coded, 2-pin, PUR cable blue, NAMUR



Dimensions

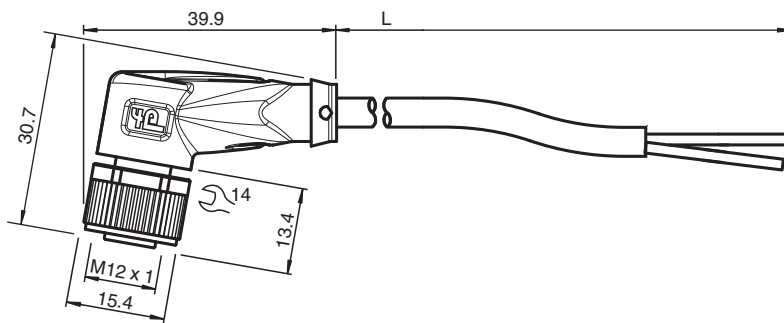

Technical Data

General specifications

Connector 1	
Connection	socket
Construction type	M12
Style	angled
Locking	screw connection
Number of pins	2
Coding	A-coded
Connector 2	
Connection	cable end

Electrical specifications

Operating voltage	U_B	max. 250 V AC/DC
Operating current	I_B	4 A
Inductance per unit length	R'	max. 0.057 Ω/m
Capacitance per unit length	C'	102.4 nF/km
Inductance per unit length	L'	0.49 mH/km

Conformity

Release date: 2022-03-20 Date of issue: 2022-03-20 Filename: 109477_eng.pdf

Refer to "General Notes Relating to Pepperl+Fuchs Product Information".

Pepperl+Fuchs Group
www.pepperl-fuchs.com

USA: +1 330 486 0001
fa-info@us.pepperl-fuchs.com

Germany: +49 621 776 1111
fa-info@de.pepperl-fuchs.com

Singapore: +65 6779 9091
fa-info@sg.pepperl-fuchs.com

PEPPERL+FUCHS

Technical Data

Degree of protection	EN 60529	
Plug connection	connector M12 x 1 : IEC 61076-2-101	
Ambient conditions		
Ambient temperature		
Plug connector	-40 ... 90 °C (-40 ... 194 °F)	
Cable, fixed	-40 ... 80 °C (-40 ... 176 °F)	
Cable, flexing	-20 ... 80 °C (-4 ... 176 °F)	
Pollution degree	3	
Mechanical specifications		
Plug connector		
Tightening torque	0.6 Nm	
Loosening protection	available	
Tool installation	straight knurling and hexagon nut SW = 14 mm	
Mating cycles	min. 100	
Degree of protection	IP68 / IP69	
Cable	according to IEC/EN 60228 (DIN VDE 0295) class 6	
Sheath diameter	4.8 mm	
Bending radius	> 15 x cable diameter, moving > 10 x cable diameter, fixed	
Sheath color	blue (similar to RAL 5015)	
Number of cores	2	
Core cross section	0.34 mm ²	
Cores color	Core 1: brown Core 2: blue	
Core construction	42 x 0.1 mm Ø	
Length	L	2 m
Cable code	Li FY 11Y 2 x 0.34	
Material		
Plug connector		
Screw connection	Zinc diecast, nickel-plated	
Body	TPU, black	
Seal	FKM	
Contact surface	Au	
Flammability	V-2	
Cable		
Sheathing	PUR based on polyether	
Core insulation	PVC	
Flammability	HB	



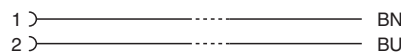
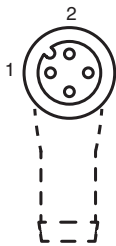



Connection Assignment



Accessories

	MH V1-SCREWDRIVER	torque screwdriver (0.6 Nm)
---	--------------------------	-----------------------------

Accessories

	MH V1-BIT M12	plug-in cap M12
	V1/V3-LABELHOLDER	Label holder
	V1/V3-LABEL	Label plate
	MH V1-Holder	Modular universal holder for M12 connectors
	V1-CLIP	Unlocking protector for M12 connector
	V1-MARKING-RING-COLOR	Marking rings for M12 connectors, various colors